

1/6

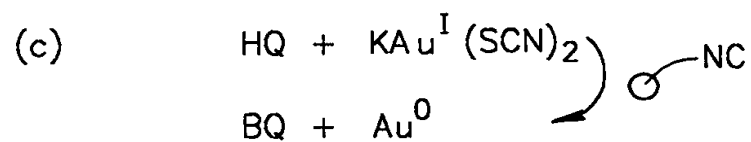

FIG.1

FIG. 2

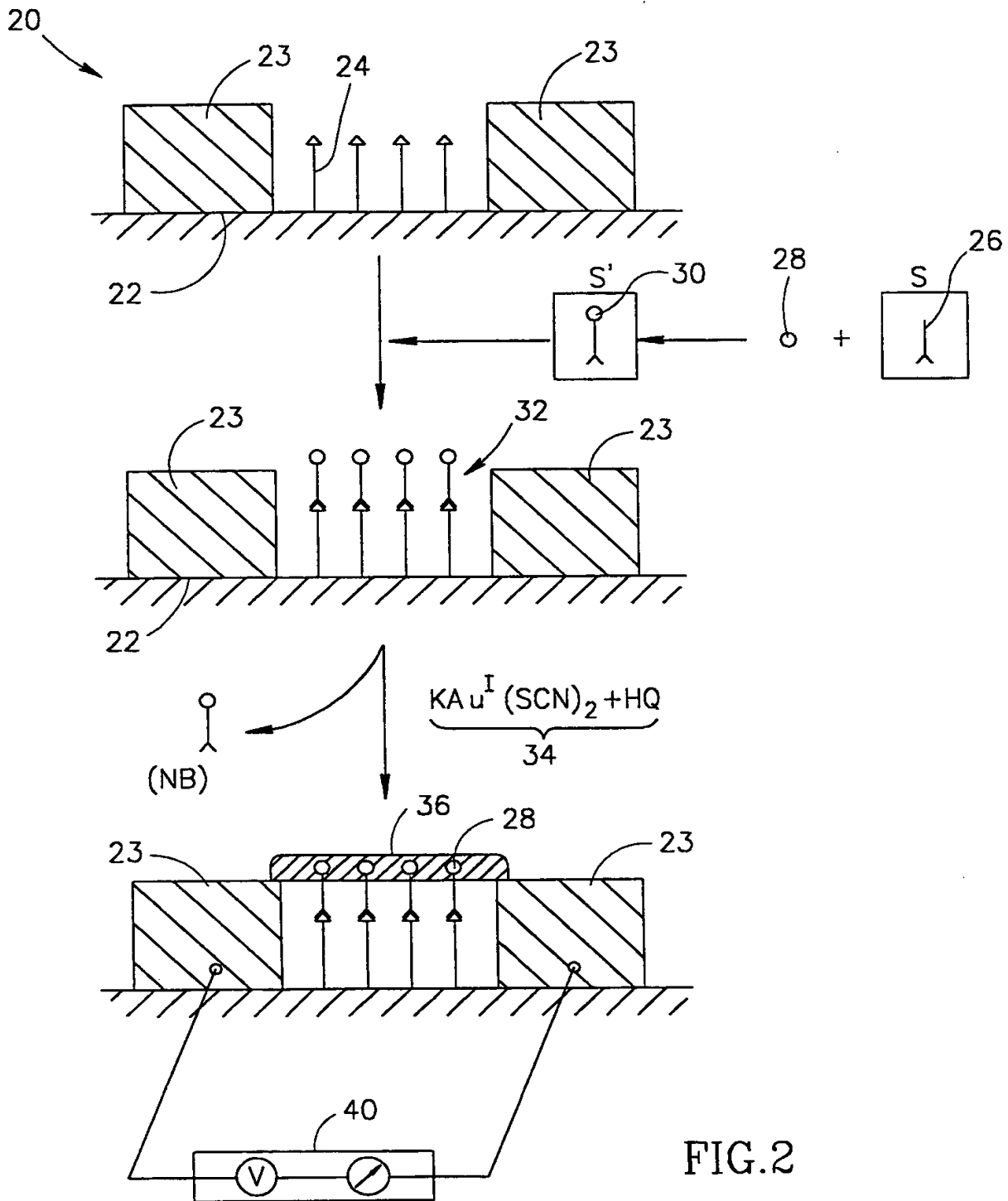

FIG. 2

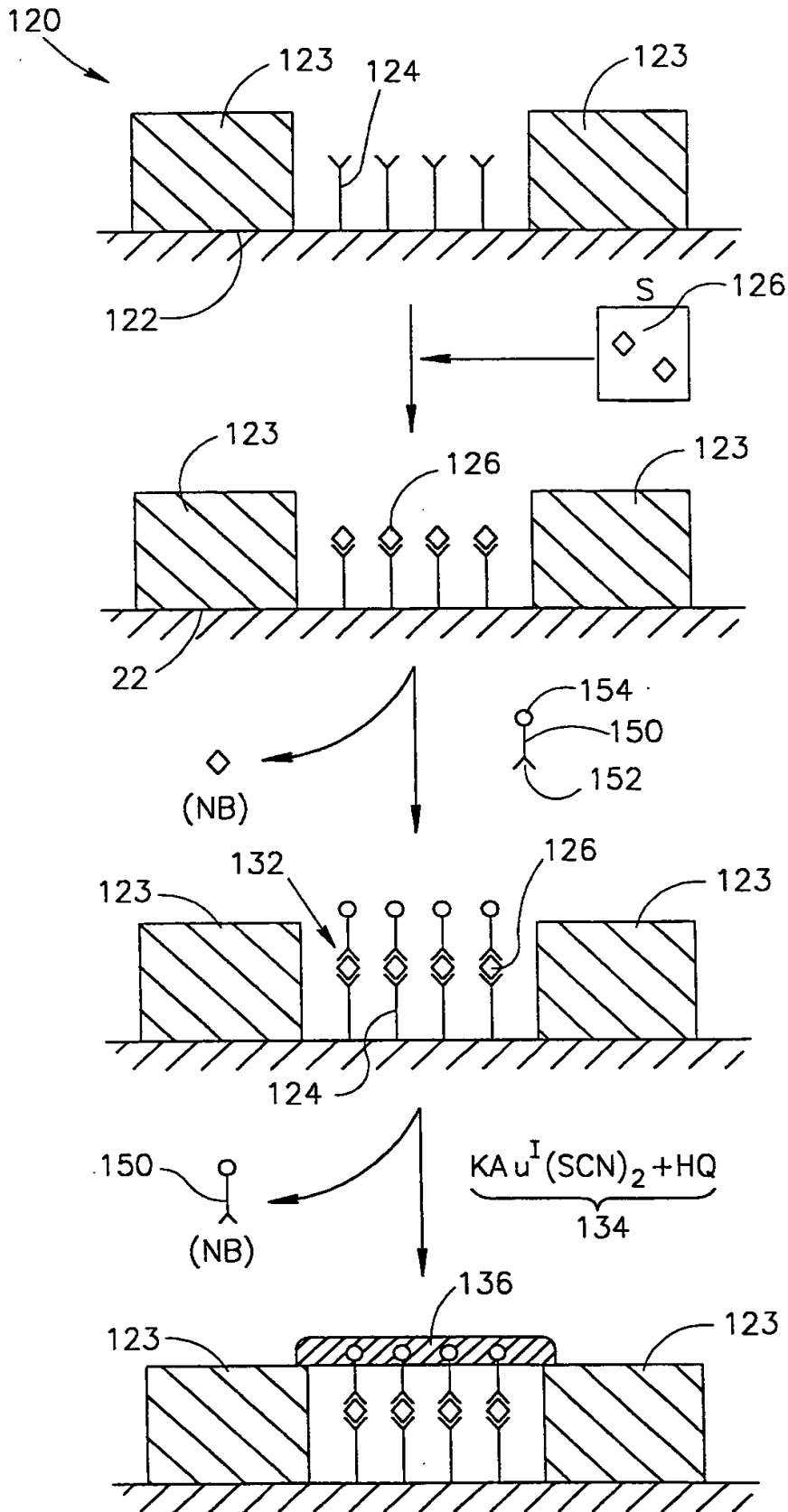

FIG. 3

Pub. No. 00/25136

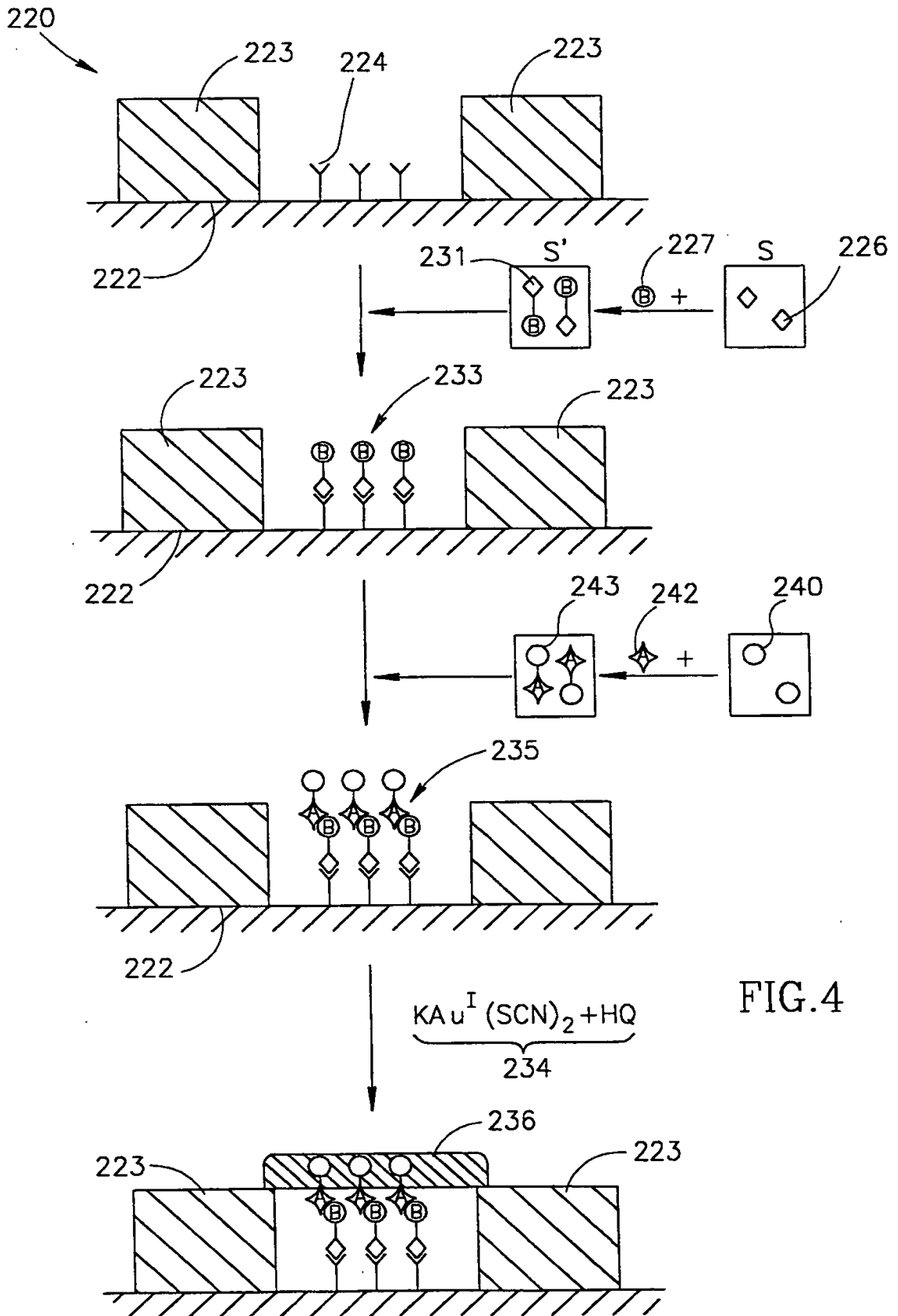

FIG.4

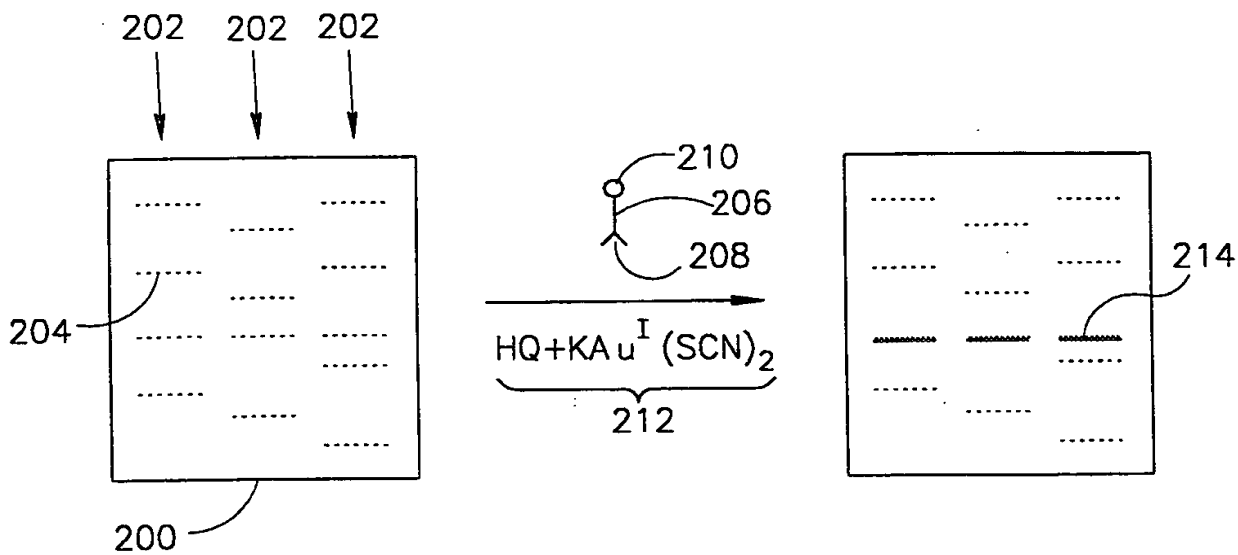

FIG.5

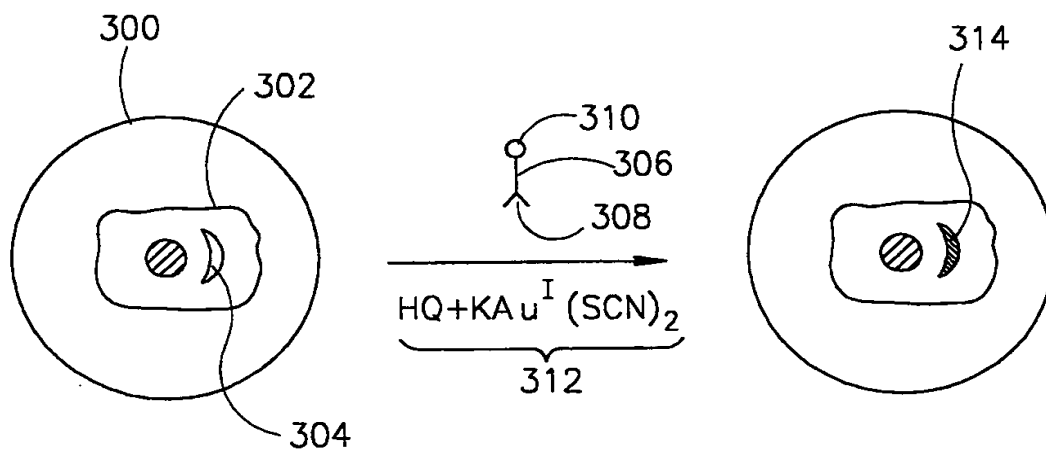

FIG.6

Pub. No. 2001/02660

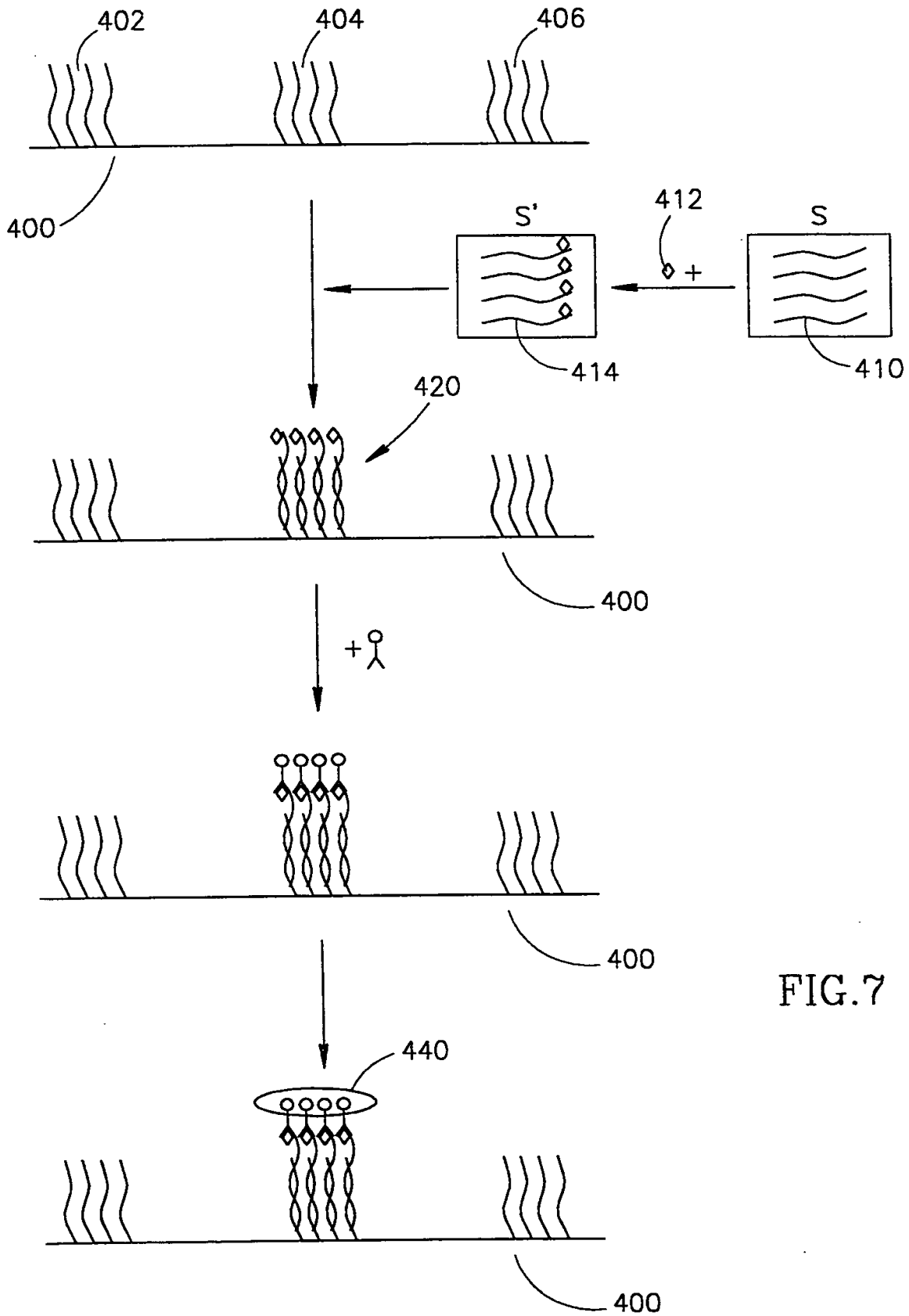

FIG. 7